

ANCHOR AND ANCHOR TROLLEY

INSTALLATION INSTRUCTIONS

Parts List

1.

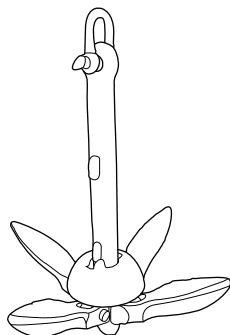

2.

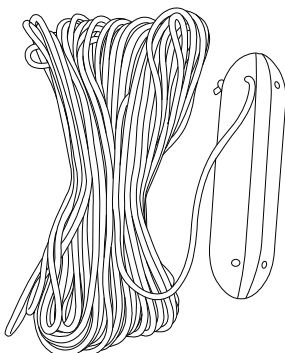

3.

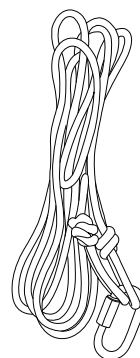

4.

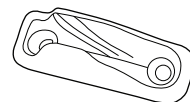

5.

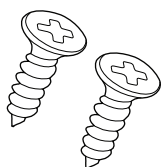

6.

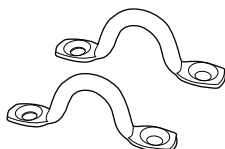

7.

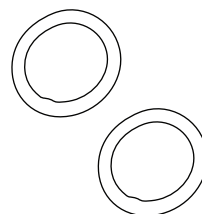

8.

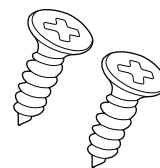

No.	Part number	Description	Qty.
1	3101080027000	Anchor	1
2	3101060017000/3101110001000	Rope Spinner/Rope Black 30 m.	1
3	3101110001000/3102080033000	Rope Black/Quick Link	1
4	3102080061000	Cleat	1
5	3101040083000	Screw FH-STL M4X15	6
6	3102080029000	Pad eye	2
7	3102080032000	Round ring	2
8	3101040083000	Screw FH-STL M4X20 Head 6 mm.	2

Installation Manual

- 1.** On the right side of your kayak facing forward, start by placing the cleat and marking the holes using a marker.

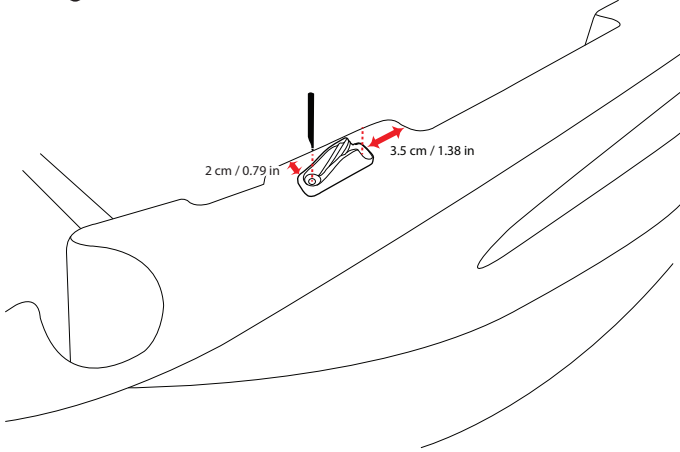

- 2.** Using a \varnothing 3 mm drill bit, make two holes for the screws. You can drill with the cleat in place or simply use your marks.

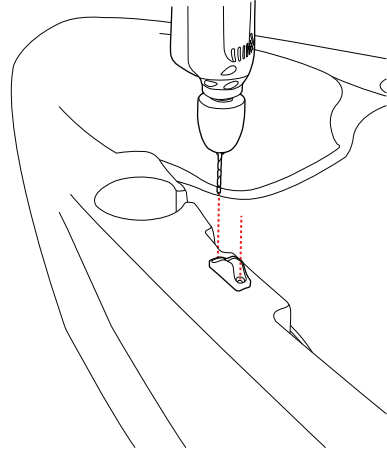

- 3.** Next secure the cleat using the screws supplied.

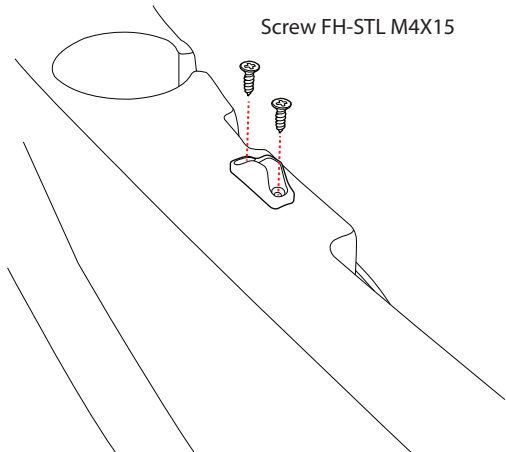

- 4.** Mark the location of your first pad eye, we recommend you place it near the back of where the seat sets as shown.

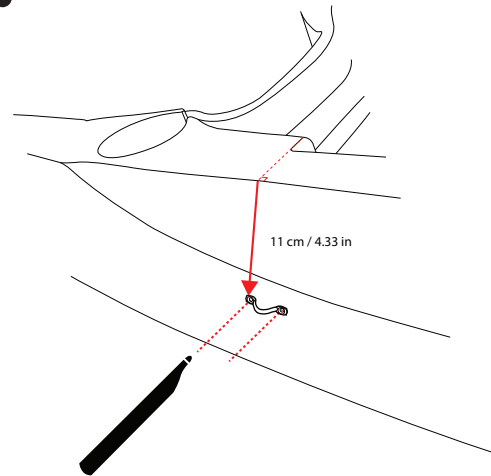

- 5.** Using a \varnothing 3 mm drill bit, make two holes for your screws.

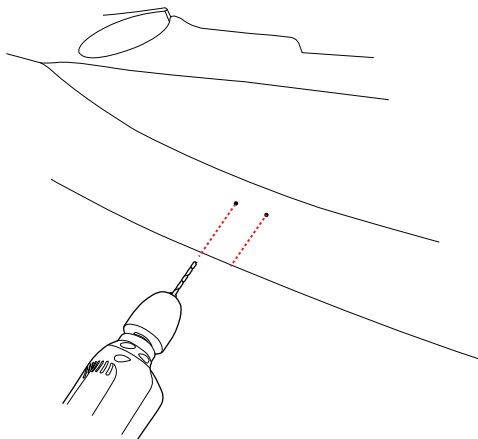

- 6.** Next, get one of the rings and place one end behind the pad eye as shown.

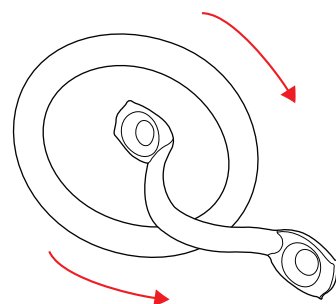

Installation Manual

7. Secure the pad eye using the screws supplied.

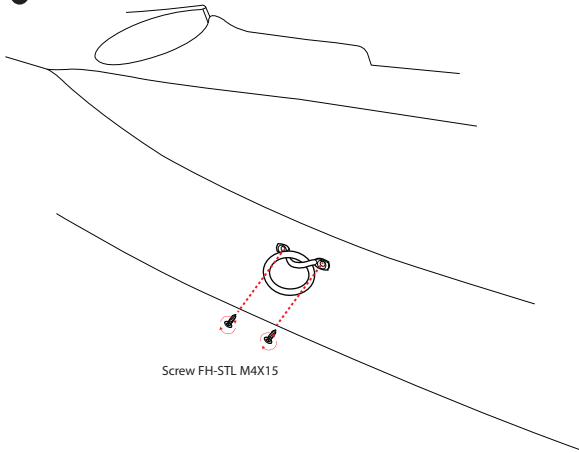

8. Mark the location of your second pad eye. We recommend you install it towards the rear (stern) of your kayak as shown.

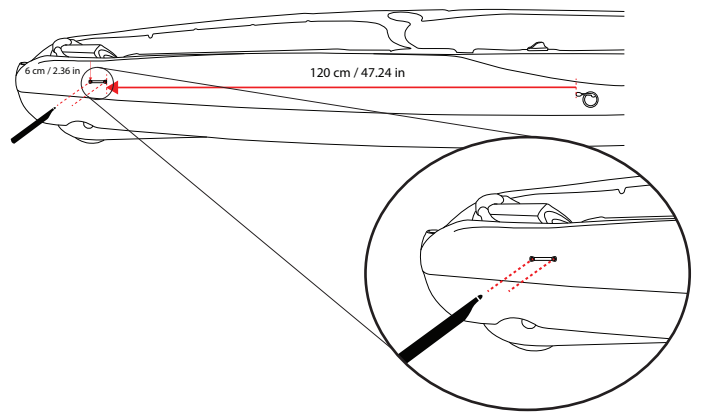

9. Using a $\varnothing 3$ mm drill bit, make two holes for your screws.

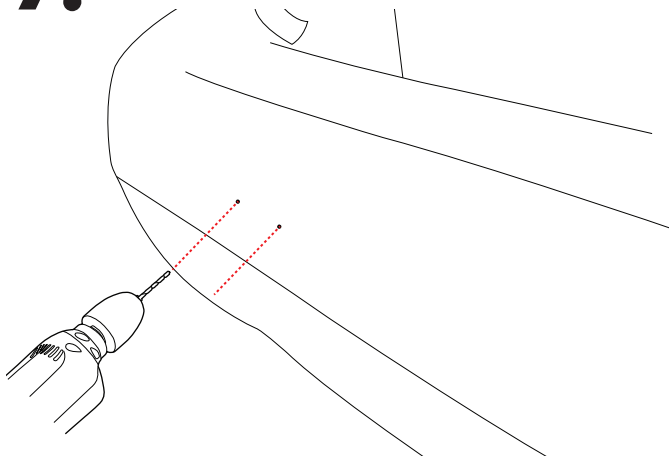

10. Next, get one of the rings and place one end behind the pad eye as shown and secure using the screws supplied.

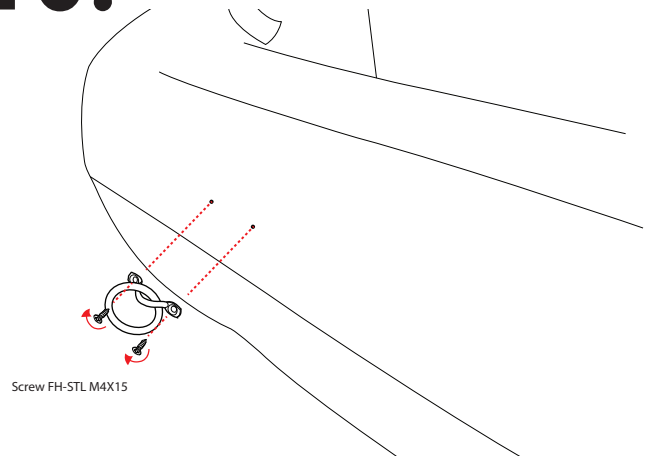

11. Insert one end of the supplied rope through ring closest to the center of your kayak.

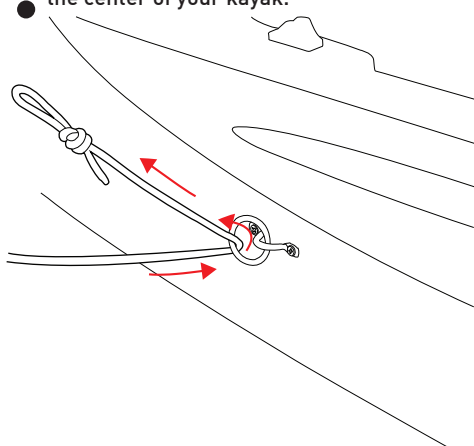

12. Bring the rope over to the rear and insert through second ring.

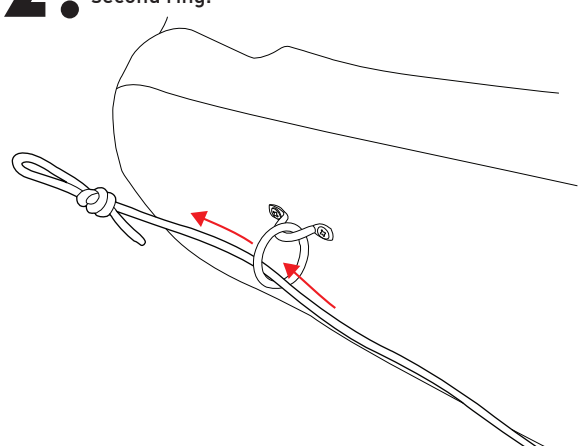

Removal Manual

13. Bring the loop back towards the center of the kayak and use the supplied quick link. Note: if needed you may need to adjust your rope length if too tight or loose.

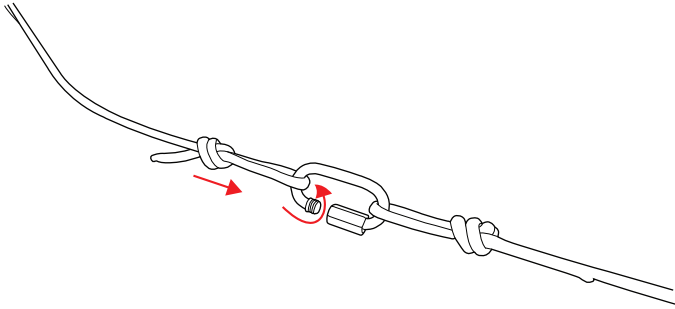

14. Tie one end of the anchor rope to your anchor, make sure it secure by pulling on it several times while holding the anchor down with your feet.

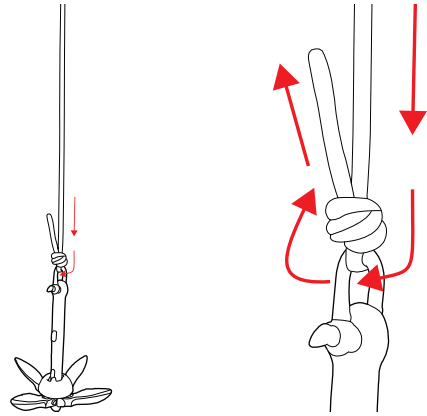

15. Bring the other end of the rope through the quick link and secure to your anchor cleat.

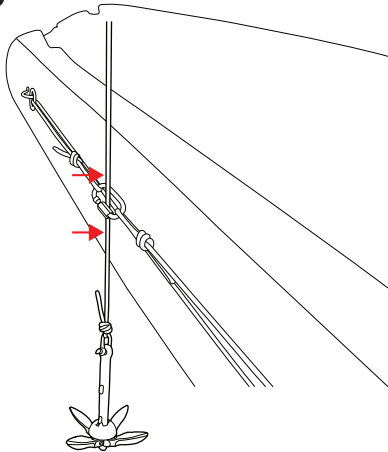

16.

